

CROWD BARRIER FOR "HEAVY DUTY" APPLICATIONS

MODULAR SYSTEM «HD»
120 & 200 SERIES



**SOCIAL
DISTANCING
SOLUTIONS**

LITEC «HD» CROWD BARRIER – 120 & 200 Series

- Crowd barriers are commonly used at events calling for demarcation or prohibition of access to and from open spaces;
- They are made in aluminum EN6082 T6 alloy, a durable and absolutely environmental friendly material;
- Design horizontal load applied on top rail: 300 kg per meter length, according to EN 13200-3;
- 120 & 200 Series are engineered for HEAVY DUTY applications, made of modular elements based on 1035 mm width;
- The special slope on front board avoids accidental tripping;
- They are also known as “anti-panic” barrier in view of their robust construction. Once bolted together they deliver a firmly anchored fence that will remain in place even in very agitated situations.



LITEC «HD» CROWD BARRIER – 120 & 200 Series

- They fold flat after use and can be stacked on dollies for easy transport and storage.
- They distinguish themselves comparing to steel systems available in the market for their high quality, corrosion and aging resistance, offering a combination of optimum safety and comfort for both the audience and rescue personnel;
- 120 & 200 series can also be combined together;
- Our Engineering Team is available for all possible customizations needs;



Code: LT CWB-B

Description:

Litec “HD” Crowd Barrier 120 Series standard foldable. (C)

Weight:

42.3 kg

Dimensions [mm]:

width 1035 x depth 1250 x height 1185

**Design horizontal load applied on handrail:
300 kg per meter length, according to
annex B, C of the EN 13200-3**

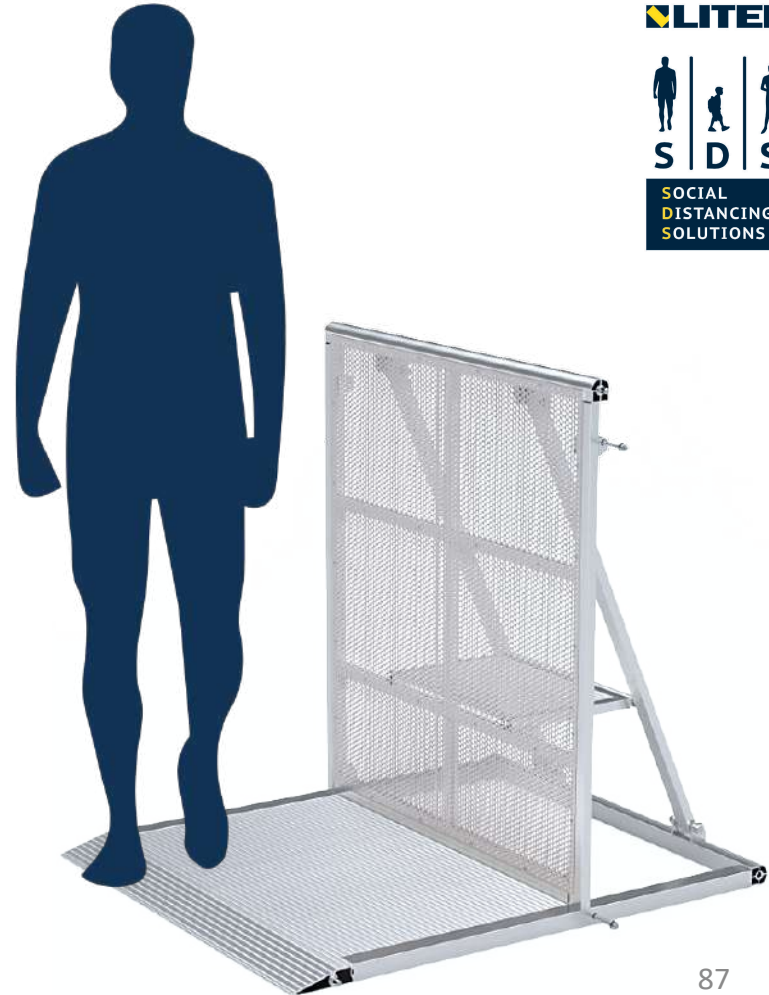

Code: LT CWB-BH

Description: Litec “HD” Crowd Barrier 120 Series half size unit foldable. (C)

Weight:

20.8 kg

Dimensions [mm]:

width 518 x depth 1250 x height 1185



Code: LT CWB-B03G5

Description:

Litec “HD” Crowd Barrier 120 Series
Angled @ 3,5 degrees foldable. (I)

Weight:

40.5 kg

Dimensions [mm]:

width 1035 x depth 1250 x height 1185

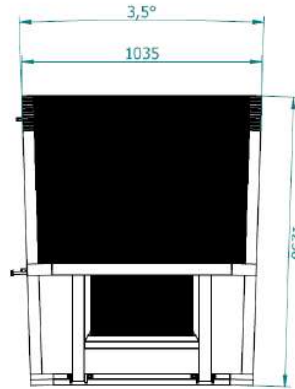
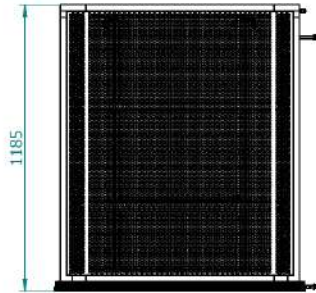
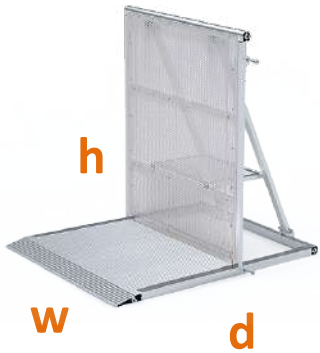

**EXAMPLE OF LITEC
CROWD BARRIER
“HD” 120 SERIES
ANGLED AT 3.5°
MADE OF:**

5 x Code: LT CWB-B03G5

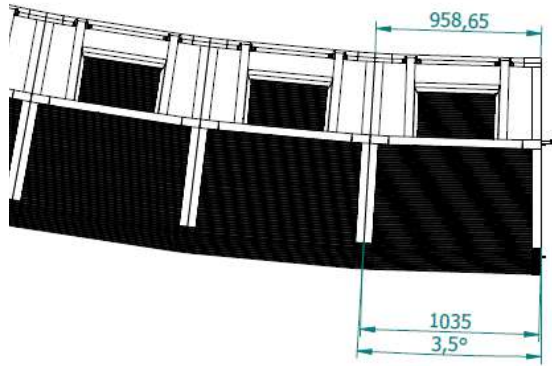

Code: LT CWB-APLH

Description:

Litec “HD” Crowd Barrier 120 Series foldable frame adapter to Prolyte Stagedex crowd barrier “left” side. (I)

Weight:

22.3 kg

Dimensions [mm]:

width 517,5 x depth 1250 x height 1207



HOW IT
LOOKS
WHEN
ATTACHED
TO THE
BARRIER



STAND ALONE ELEMENTS

Code: LT CWB-APRH

Description:

Litec “HD” Crowd Barrier 120 Series foldable frame adapter to Prolyte Stagedex crowd barrier “right” side. (l)

Weight:

22.3 kg

Dimensions [mm]:

width 517,5 x depth 1250 x height 1207



HOW IT
LOOKS
WHEN
ATTACHED
TO THE
BARRIER



STAND ALONE ELEMENTS

Code: LT CWB-BC

Description:

Litec "HD" Crowd Barrier 120 Series foldable with cable access. (C)

Weight:

49.3 kg

Dimensions [mm]:

width 1035 x depth 1250 x height 1185



Code: LT CWB-DC

Description: Litec “HD” Crowd Barrier 120 Series foldable with 700 mm. width gate access.

It cannot be used as an emergency exit. (C)

Weight:

50.3 kg

Dimensions [mm]:

width 1035 x depth 1250 x height 1185



Code: LT CWB-EG

Description: Litec “HD” Crowd Barrier 120 Series emergency gate (two pieces foldable) made of two door, for a total width opening of 1220 mm. (I)

Weight:
100.8 kg

Dimensions [mm]:
width 2100 x depth 1250 x height 1185



BACK VIEW



FRONT VIEW

Code: LT CWB-TG

Description: Litec “HD” Crowd Barrier 120 Series truck gate. (I)

Weight:

218.3 kg

Dimensions [mm]:

width 4220

depth 1250

height 1185

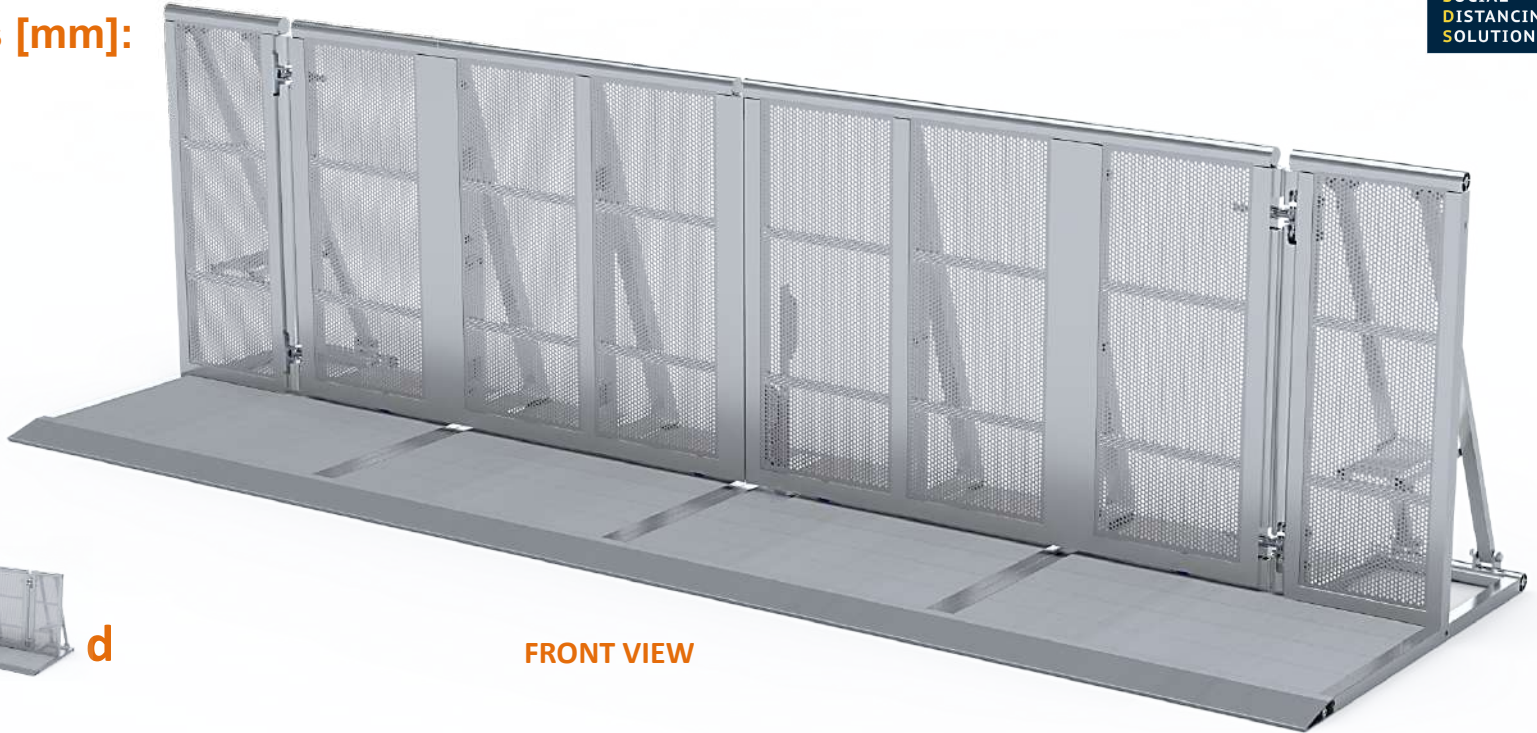

FRONT VIEW

Code: LT CWB-TG

Description: Litec “HD” Crowd Barrier 120 Series truck gate. (I)



**SOCIAL
DISTANCING
SOLUTIONS**



BACK VIEW

Code: LT CWB-TG

Description: Litec “HD” Crowd Barrier 120 Series truck gate. (I)



SOCIAL
DISTANCING
SOLUTIONS

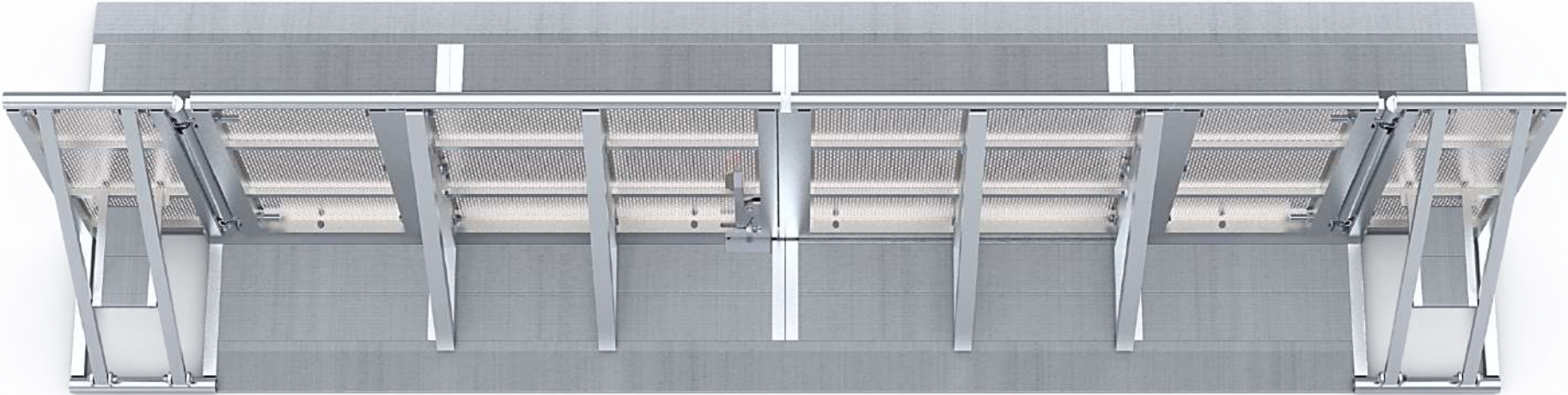

TOP BACK VIEW

Code: LT CWB-VC

Description: Litec “HD” Crowd Barrier 120 Series foldable, continuous variable adjustable corner with angles settings $0^{\circ}/+60^{\circ}/-60^{\circ}$. (C)

Weight:

38.3 kg

Dimensions [mm]:

width 922 x depth 1250 x height 1185



Code: LT CWB-VLC

Description: Litec “HD” Crowd Barrier 120 Series vario light with adjustable angle 0°/+90°/-90°, lower cable slot dimensions 800 mm. width by 150 mm. height. (I)

Weight:

19.1 kg

Dimensions [mm]:

width 922 x depth 50 x height 1185



**HOW IT
LOOKS
WHEN
ATTACHED
TO THE
BARRIER**

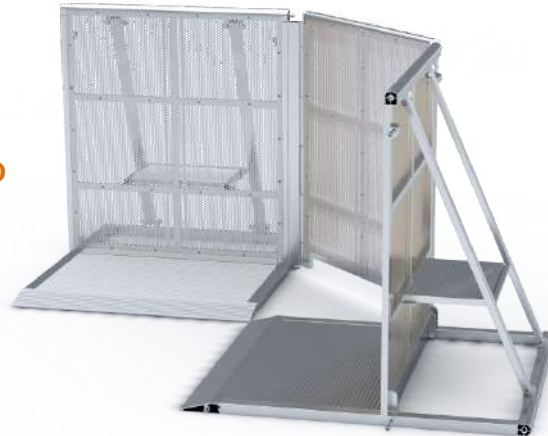

Code: LT CWB-VL

Description: Litec “HD” Crowd Barrier 120 Series vario light with adjustable angle 0°/+90°/-90°. (I)

Weight:

19.3 kg

Dimensions [mm]:

width 922 x depth 50 x height 1185



**HOW IT
LOOKS
WHEN
ATTACHED
TO THE
BARRIER**



Code: LT CWB-T

Description: Litec “HD” Crowd Barrier 120 Series 90° angle adapter made of two separate elements. (I)

Barrier Frame Dimensions [mm]:

width 776 x depth 50 x height 1185 mm.

Weight:

16.9kg

Floor Adaptor Dimensions [mm]:

width 50 x depth 865 x height 50 mm.

Weight:

1.2kg

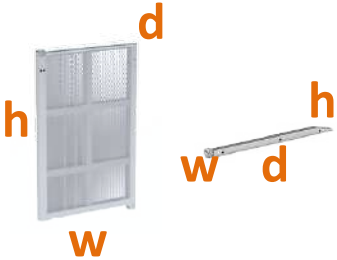

EXAMPLE OF LITEC CROWD BARRIER

“HD” 120 SERIES

90° CORNER SET

MADE OF:

3 x Code: LT CWB-B

1 x Code: LT CWB-T



LT CWB-T

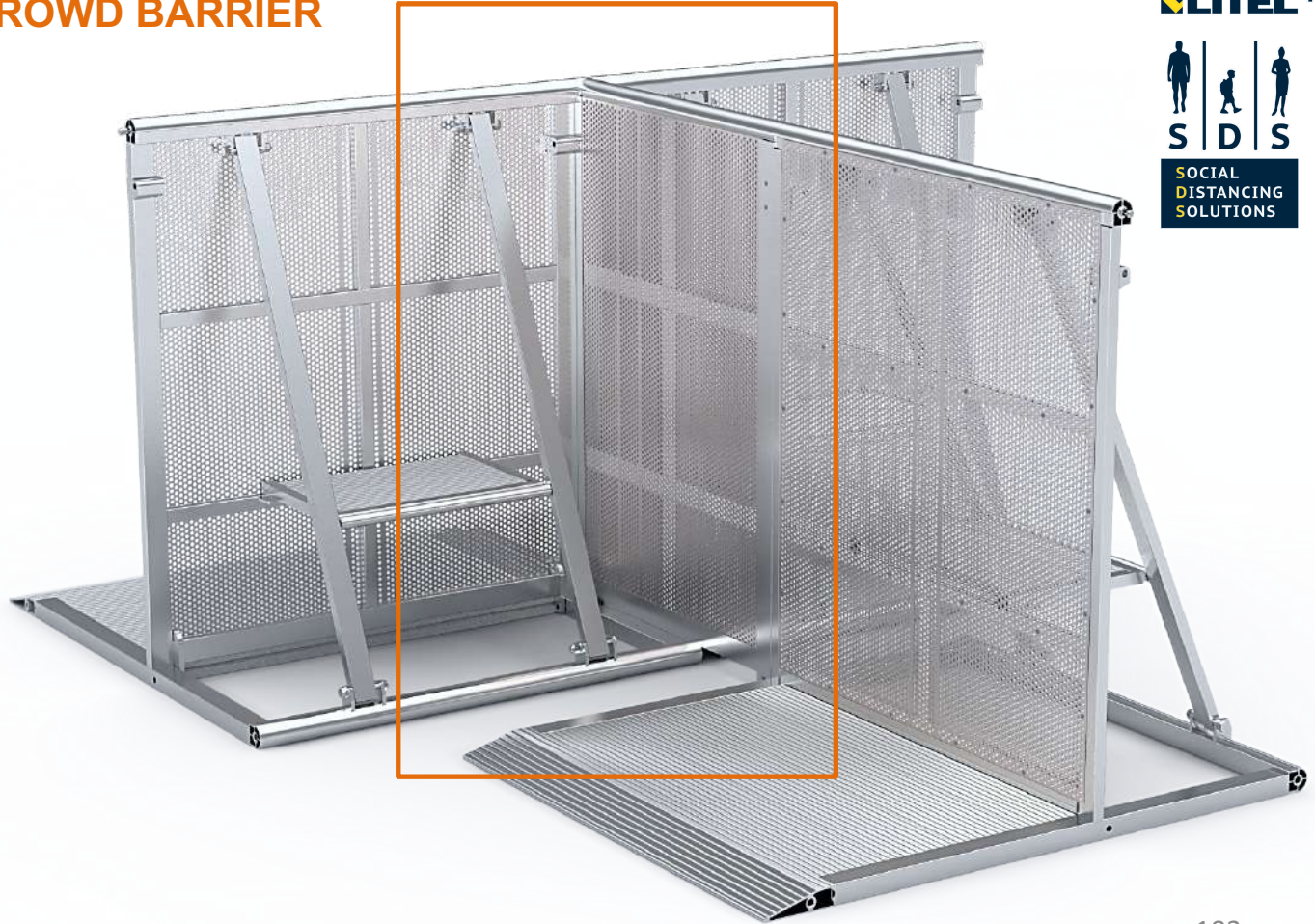

LITEC⁴



SOCIAL
DISTANCING
SOLUTIONS

EXAMPLE OF LITEC CROWD BARRIER "HD" 120 SERIES

90° CORNER SET MADE OF:

4 x Code: LT CWB-B

1 x Code: LT CWB-T

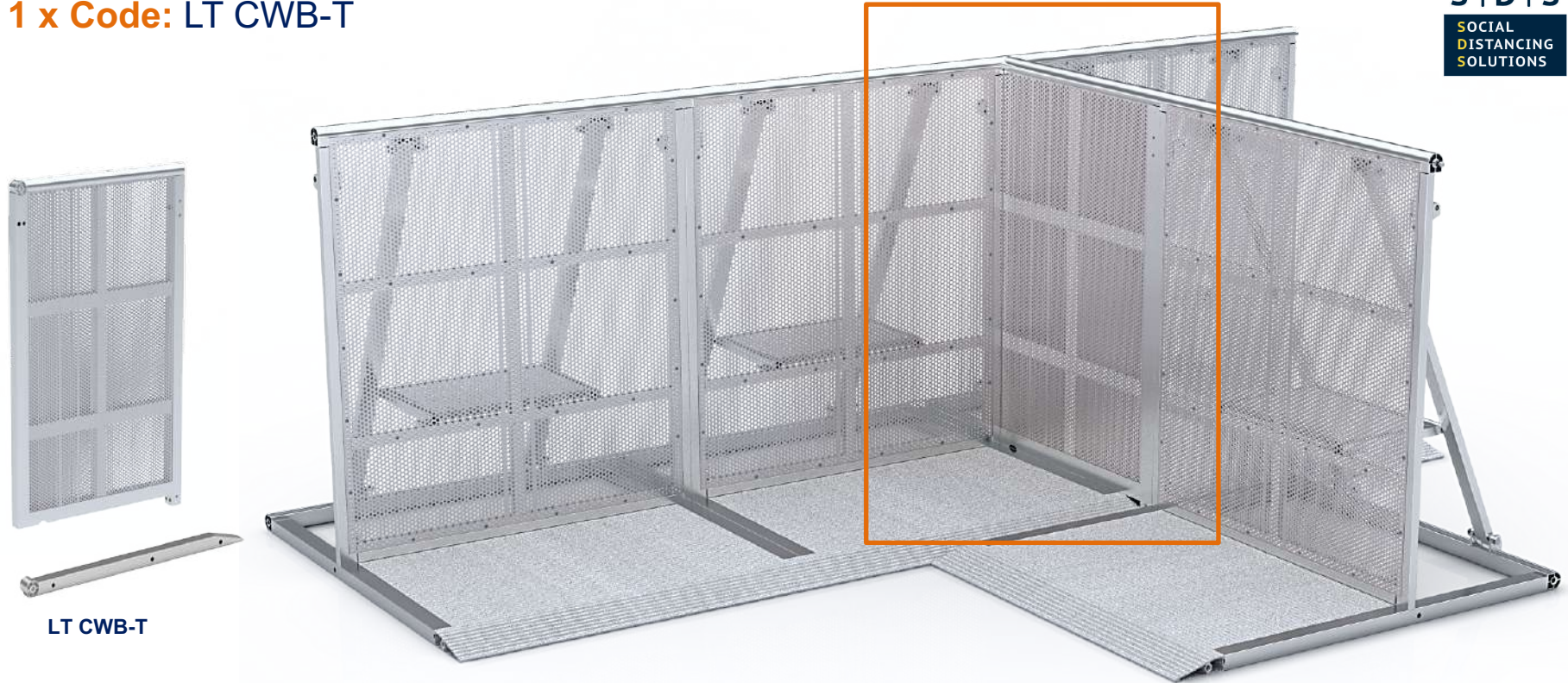

LT CWB-T

Code: LT CWB-OC03G5

Description:

Litec “HD” Crowd Barrier 120 Series
3.5° fixed angle inclinor, made of 2 pieces. (I)

Weight:

10.0 kg

Dimensions [mm]:

width 196 x depth 1250 x height 1185

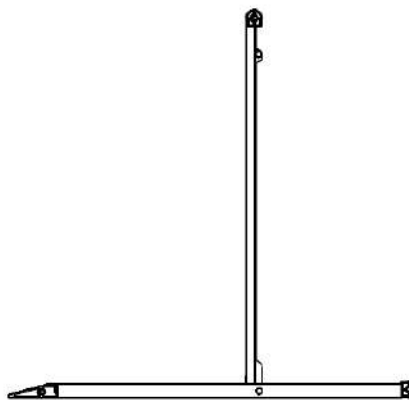

SIDE VIEW



BACK VIEW

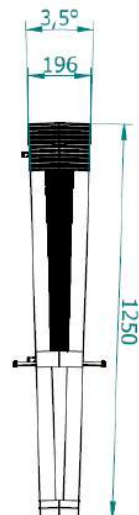

TOP VIEW



**STAND ALONE
ELEMENT**

**EXAMPLE OF
LITEC
CROWD
BARRIER
“HD” 120 SERIES
WITH
3.5° FIXED
ANGLE
INCLINATOR
MADE OF:**

7 x Code: LT CWB-B

6 x Code: LT CWB-OC03G5

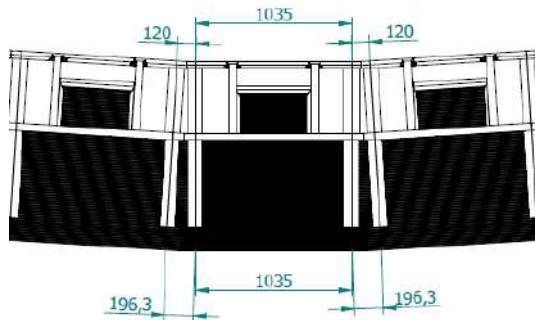

Code: LT CWB-OC90

Description: Litec “HD” Crowd Barrier 120 Series outside corner 90° made of two elements base + vertical frame barrier. (I)

Weight:

30.4 kg

Dimensions [mm]:

width 1778 x depth 968 x height 1185 mm.

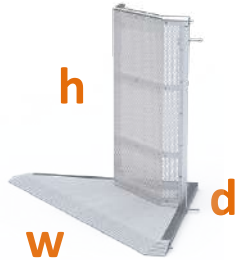

BACK VIEW



Code: LT CWB-IC90

Description: Litec “HD” Crowd Barrier 120 Series inside corner 90° made of two elements base + vertical frame barrier. (I)

Weight:

27.5 kg

Dimensions [mm]:

width 1775 x depth 884 x height 1185 mm.



BACK VIEW



Code: LT CWB-IC30

Description: Litec “HD” Crowd Barrier 120 Series foldable inside corner 30°. (I)

Weight:

15.8 kg

Dimensions [mm]:

width 686 x depth 1250 x height 1185 mm.

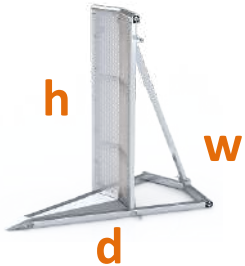
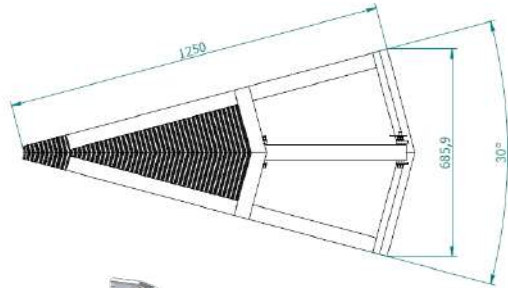

BACK VIEW



Code: LT CWB-IC22G5

Description: Litec “HD” Crowd Barrier 120 Series foldable inside corner 22,5°. (I)

Weight:

14.2 kg

Dimensions [mm]:

width 547 x depth 1250 x height 1185 mm.

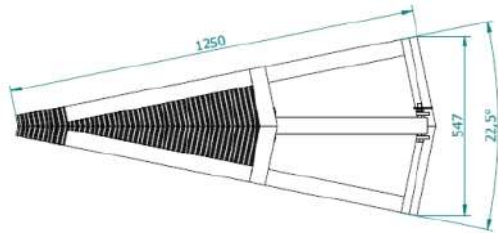

BACK VIEW



Code: LT CWB-90C

Description: Litec “HD” Crowd Barrier 120 Series 90° angle compensator. (I)

Weight:

8.1 kg

Dimensions [mm]:

width 425 x depth 141 x height 1185 mm.



Code: LT CWB-SGA

Description: Litec “HD” Crowd Barrier 120 Series single check point access short one piece foldable. (I)

Weight:

57.6 kg

Dimensions [mm]:

width 1423 (ramp only 600 mm)

depth 1100

height 1185 mm.



SIDE VIEW



LITEC "HD" CROWD BARRIER 120 SERIES TWO ENTRANCE CHECK POINT

MADE OF:

2 x Code: LT CWB-B

4 x Code: LT CWB-90C

2 x Code: LT CWB-SGA

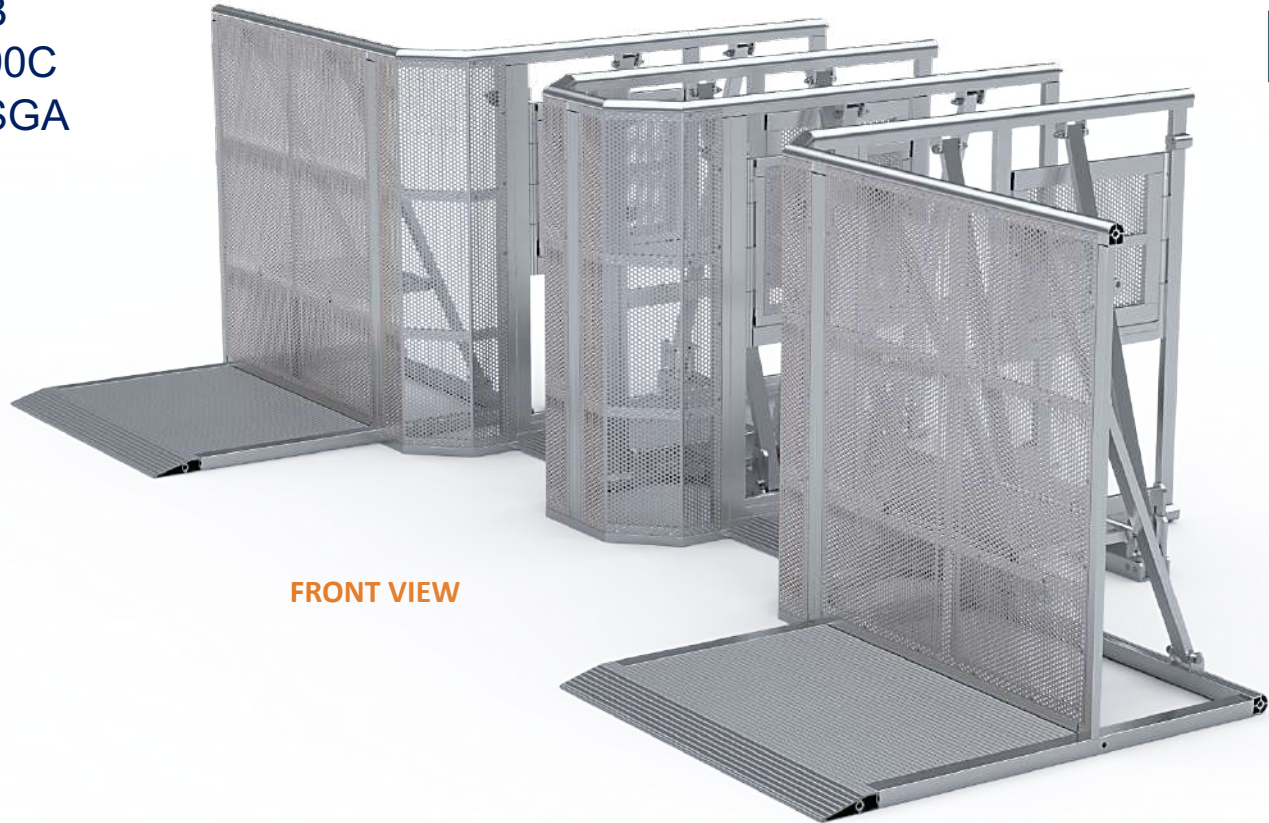

FRONT VIEW

LITEC "HD" CROWD BARRIER 120 SERIES TWO ENTRANCE CHECK POINT

MADE OF:

2 x Code: LT CWB-B

4 x Code: LT CWB-90C

2 x Code: LT CWB-SGA



BACK VIEW

LITEC "HD" CROWD BARRIER 120 SERIES TWO ENTRANCE CHECK POINT WITH SOCIAL DISTANCE CONFIGURATION

MADE OF:

- 3 x Code: LT CWB-B
- 4 x Code: LT CWB-90C
- 2 x Code: LT CWB-SGA
- 3 x Code: LT CWB-RR
- 3 x Code: LT CWB-RL



FRONT VIEW

Code: LT CWB-V-CART

Description:

Litec “HD” Crowd Barrier 120 Series carrying and stocking basket trolley for 10 pieces LT-CWB-B, flat storing. (C)

Weight:

50.3 kg

Dimensions [mm]:

width 1155 x depth 1360 x height 1272 mm.

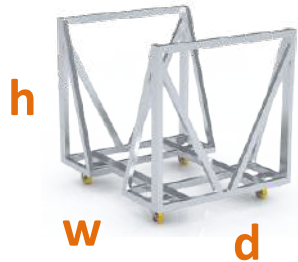

Code: LT CWB-V-CARTF

Description:

Litec “HD” Crowd Barrier 120 Series carrying and stocking basket “foldable” trolley for 10 pieces LT-CWB-B, horizontal storing. (I)

Weight:

68.7 kg

Open size dimensions [mm]:

width 1200 x depth 1388 x height 1272 mm.

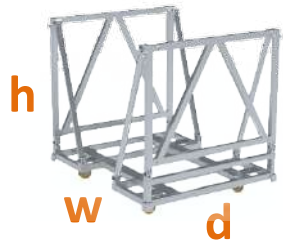

Code: LT CWB-V-CARTF

Description:

Litec “HD” Crowd Barrier 120 Series carrying and stocking basket “foldable” trolley for 10 pieces LT-CWB-B, horizontal storing. (I)

Weight:

68.7 kg

Dimensions when is closed [mm]:

width 1200 x depth 1388 x height 411 mm.



SOCIAL
DISTANCING
SOLUTIONS

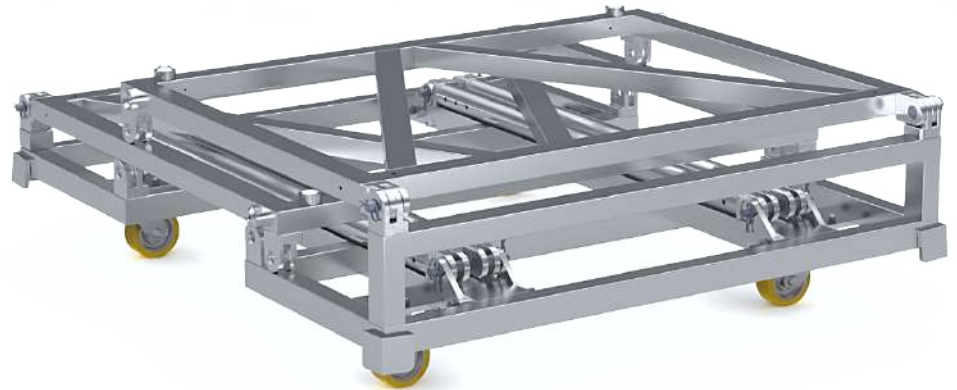
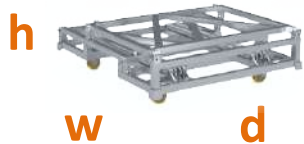

Code: LT CWB-V-CARTV

Description:

Litec “HD” Crowd Barrier 120 Series carrying and stocking basket for 10 pieces LT-CWB-B, vertical storing. (I)

Weight:

62.1 kg

Dimensions [mm]:

width 996 x depth 1412 x height 1395 mm.

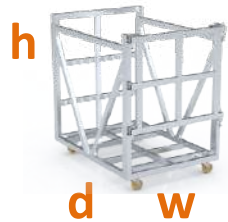

Code: LT CWB-TB

Description:

Litec “HD” Crowd Barrier 200 Series standard foldable. (I)

Weight:

51.8 kg

Dimensions [mm]:

width 1035 x depth 1250 x height 2060 mm.

Design horizontal load applied 300 kg per meter length at height of 1100 mm above the datum, according to annex B of the EN 13200-3



Code: LT CWB-TDC

Description:

Litec “HD” Crowd Barrier 200 Series
barrier foldable with 70 cm. width gate access. (C)

Weight:

65.5 kg

Dimensions [mm]:

width 1035 x depth 1250 x height 2060 mm.



Code: LT CWB-TVL

Description:

Litec “HD” Crowd Barrier 200 Series
vario light with adjustable angle 0/+90°/-90°. (I)

Weight:

30.3 kg

Dimensions [mm]:

width 922 x depth 50 x height 2060 mm.

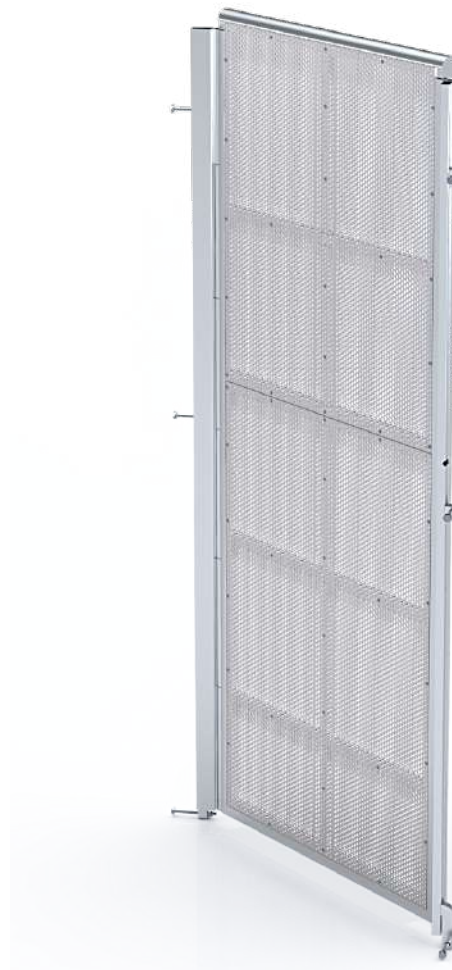

**LITEC "HD" CROWD BARRIER
200 SERIES
TWO BARRIERS CORNER
MADE OF:
2 x Code: LT CWB-TDC
4 x Code: LT CWB-TVL**



LITEC⁴



**SOCIAL
DISTANCING
SOLUTIONS**

Code: LT CWB-V-TCART

Description:

Litec “HD” Crowd Barrier 200 Series carrying and stocking basket for 10 pieces LT-CWB-BT, flat storing. (C)

Weight:

56.5 kg

Dimensions [mm]:

width 1155 x depth 2200 x height 1281 mm.

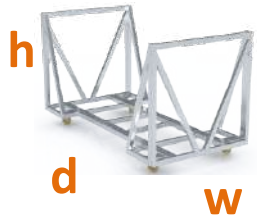

CROWD BARRIER ACCESSORIES FOR

"HEAVY DUTY" APPLICATIONS

MODULAR SYSTEM «HD»
120 & 200 SERIES



SOCIAL
DISTANCING
SOLUTIONS

Code: LT CWB-LHA

Description:

Litec “HD” Crowd Barrier 120 Series height adjuster adaptor +/-100 mm. (I)

Weight:

4.3 kg

Dimensions [mm]:

width 130 x depth 50 x height 1185

**STAND ALONE
ELEMENT**

**HOW IT
LOOKS
WHEN
ATTACHED
TO THE
BARRIER**



Code: LT CWB-SHF

Description:

Litec “HD” Crowd Barrier 120 Series shelf counter. (I)

Weight:

9.6 kg

Dimensions [mm]:

width 1035 x depth 491 x height 253



STAND ALONE ELEMENT



HOW IT
LOOKS
WHEN
ATTACHED
TO THE
BARRIER



Code: LT CWB-RR

Description:

Litec “HD” Crowd Barrier 120 & 200 Series
no trip right side ramp. (I)

Code: LT CWB-RL

Description:

Litec “HD” Crowd Barrier 120 & 200 Series
no trip left side ramp. (I)

Weight:

4.5 kg

Dimensions [mm]:

width 200 x depth 830 x height 40



**HOW THEY LOOK
WHEN ATTACHED TO
THE BARRIER**



**SOCIAL
DISTANCING
SOLUTIONS**



STAND ALONE ELEMENTS

Code: LT CWB-RR

Description:

Litec “HD” Crowd Barrier 120 & 200 Series
no trip right side ramp. (I)

Code: LT CWB-RL

Description:

Litec “HD” Crowd Barrier 120 & 200 Series
no trip left side ramp. (I)

Weight:

4.5 kg

Dimensions [mm]:

width 200 x depth 830 x height 40



**HOW THEY LOOK
WHEN ATTACHED TO
THE BARRIER**



STAND ALONE ELEMENTS

Code: LT CWB-FC

Description:

Litec “HD” Crowd Barrier 120 & 200 Series connection kit made of:

2 x male pin M14

2 x nuts M10

2 x bolts M10

4 x washers M10

available as a spare part. (I)

Weight:

0.35 kg

